

Product Data Sheet

SFK180-S

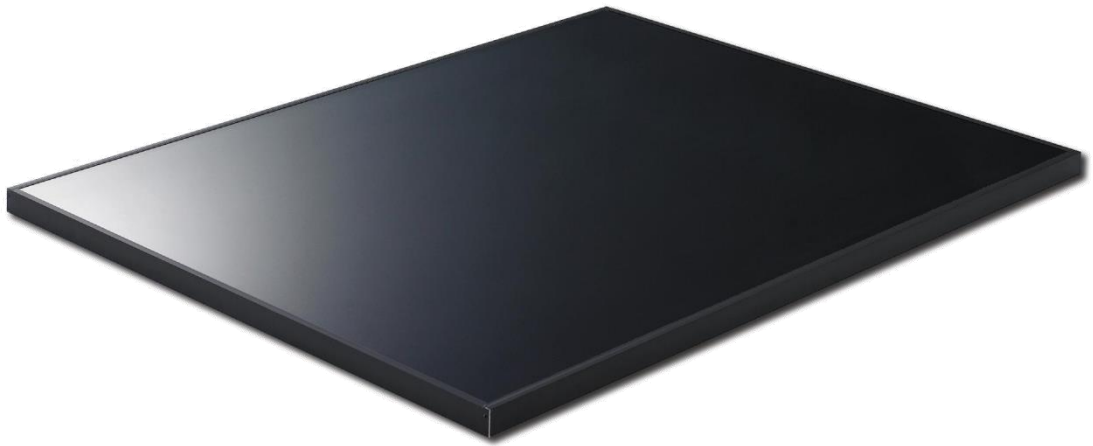

Contact

Solar Frontier K.K.

Address: 2-3-2 Daiba, Minato-ward Tokyo, 135-8074 JAPAN

Email: info@solarfrontier.co.jp

Website: www.solar-frontier.com

Certifications

IEC 61646 Ed 2.0 / IEC 61730 Ed 1.0 (JET)

UL1703 (UL)

ISO 9001

RoHS Compliant

Electrical Characteristics

Electrical Performance at Standard Test Conditions (STC) *1

Maximum Power (Pmax)	180 W
Tolerance of Pmax	+10% / - 5%
Open Circuit Voltage (Voc)	120 V
Short Circuit Current (Isc)	2.18 A
Maximum Power Voltage (Vmpp)	92.4 V
Maximum Power Current (Impp)	1.95 A

Note*1 Standard Test Conditions (STC) : 1,000 W/m² irradiance, cell temperature 25 °C and a spectral distribution of irradiance according to air mass 1.5. Isc and Voc are within ±10% tolerance of the rated values at STC.

Electrical Performance at Nominal Operating Cell Temperature (NOCT) Conditions*2

Maximum Power (Pmax)	140 W
Open Circuit Voltage (Voc)	114 V
Short Circuit Current (Isc)	1.75 A
Maximum Power Voltage (Vmpp)	92.4 V
Maximum Power Current (Impp)	1.51 A

Note*2 Nominal Operating Cell Temperature Conditions: Module operating temperature at 800 W/m² irradiance, ambient temperature 20 °C, wind speed 1m/s and open circuit condition.

Performance at Low Irradiance*3

Note*3 Efficiency reduction of maximum power from an irradiance of 1,000 W/m² to 200 W/m² at 25 °C is typically 2.0%.

Characteristics for System Design

Maximum system Voltage (Vsys)	1,500 V DC
Limiting Reverse Current (Ir)	7 A
Maximum Series Fuse Rating (Isf)	4 A

Thermal Characteristics

NOCT	47.0 °C
Temperature Coefficient of Isc (α)	+ 0.01% / K
Temperature Coefficient of Voc (β)	- 0.27% / K
Temperature Coefficient of Pmax (δ)	- 0.33% / K

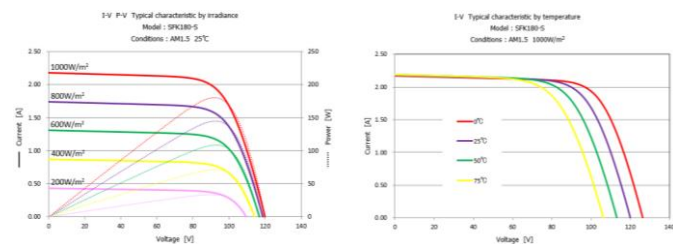

Disclaimers

Copyright for all material appearing on this Product Data Sheet belongs to Solar Frontier K.K. ("Solar Frontier"). Solar Frontier reserves the right, at its sole discretion, to change, modify, add, or delete portions of the content at any time without notice, but makes no commitment to update any content which may be out of date. The data contained in this Product Data Sheet indicates nominal data of our products. Any warranty with respect to the quality or performance of our products will be provided only based on a limited warranty certificate separately issued by Solar Frontier. See the Installation and Maintenance Guide or contact the Technical Service for further information on approved installation and use of this product.

Module Drawing

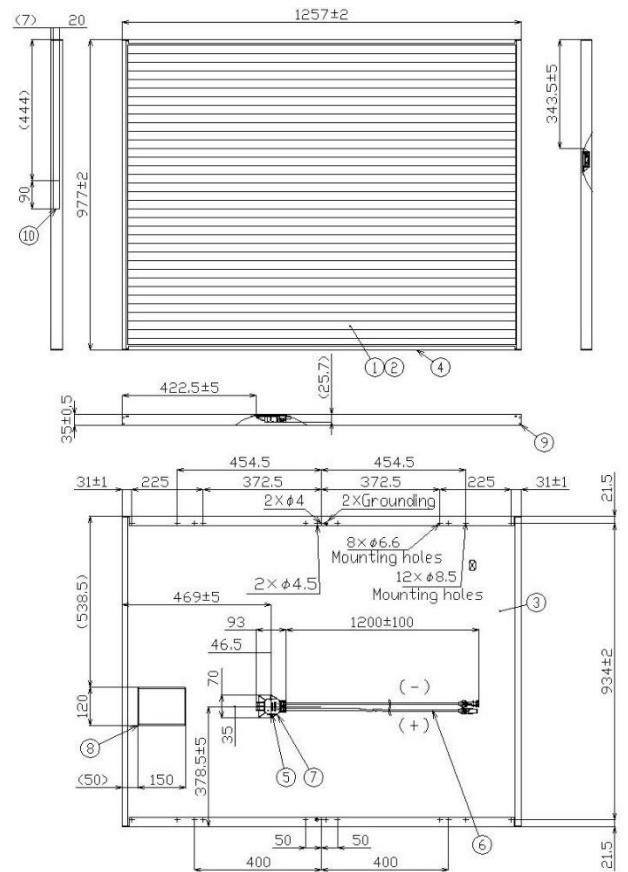

- ① Cell
- ② Cover glass
- ③ Back sheet
- ④ Frame
- ⑤ Junction box
- ⑥ Cable
- ⑦ Adhesive
- ⑧ Label
- ⑨ Screw
- ⑩ Bar code label

Mechanical Characteristics

Dimensions (L x W x H)	1,257 x 977 x 35 mm (49.5 x 38.5 x 1.4 inch)
Weight	18.5 kg (40.8 lbs)
Snow Load*4	2,400 Pa (IEC61646 Ed 2.0)
(to the front of the module)	1,600 Pa design load (UL1703)
Wind Load	2,400 Pa (IEC61646 Ed 2.0)
(to the back of the module)	1,600 Pa design load (UL1703)
Module Operating Temperature	- 40 °C ~ 85 °C
Application Class on IEC61730 Ed 1.0	Class A
Fire Safety Class on IEC61730 Ed 1.0	Class C
Safety Class on IEC61140	II
Module Fire Performance	Type 1
Cell Type	CIS substrate glass (Cadmium free)
Front Glass	Tempered anti-reflective glass
Encapsulant	EVA
Back Sheet	Weatherproof plastic film
Frame	Anodized aluminum alloy (Color: black)
Junction Box	Protection rating: IP67 (With bypass diode)
Output Cables (Conductor)	2.5 mm ² /14 AWG (Halogen free)
Cable Lengths (Symmetrical)	1,200 mm (47.2 inch)
Connectors	Hosiden, HSC2013 (Male) / HSC2014 (Female)

Note*4 UL: 1.5 times design load is applied to the module. Accordingly, 2,400 Pa (50.1 lbs / ft²) is loaded to test the 1,600 Pa (33.4 lbs / ft²) UL design load